

LONGITUDINAL PROFILE

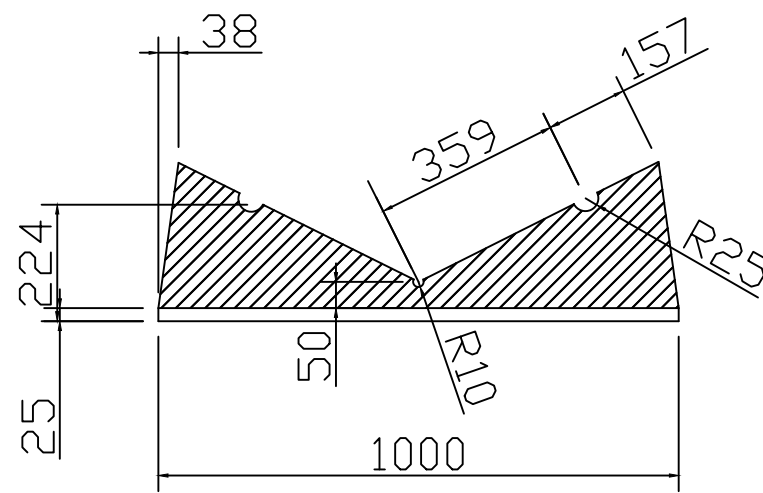

TRANSVERSAL SECTION "B"

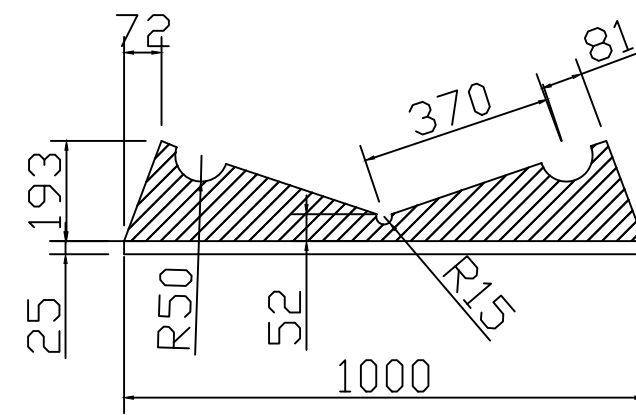

TRANSVERSAL SECTION "A"

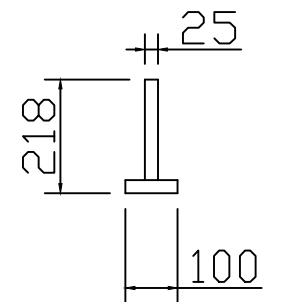

TRANSVERSAL SECTION "C"

	OM 390 CHOCK		DWN: LG
			APPROVED: LXL
info@highfieldboats.com	DWG:	SCALE:	DATE: 2019.07.15
(C) Copyright reserved. No unauthorized use allowed. All intellect - ideas - concepts remain the property of Highfield Boats			