

LONGITUDINAL PROFILE

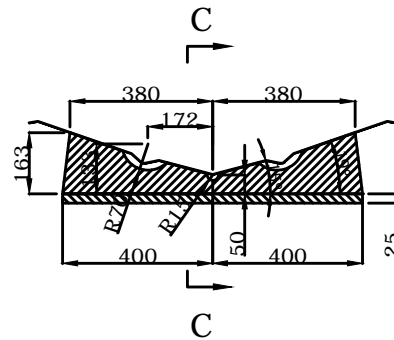

TRANSVERSAL SECTION "A"

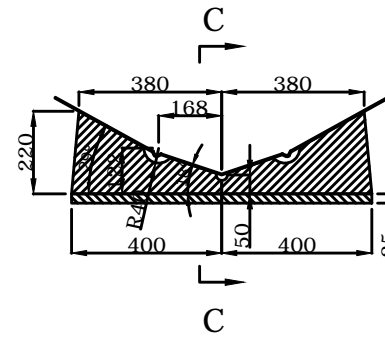

TRANSVERSAL SECTION "B"

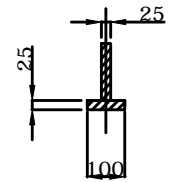

TRANSVERSAL SECTION "C"

	CL290BL		DWN: HCY
	CHOCK ARRANGEMENT		APPROVED: LXL
info@highfieldboats.com	DWG:	SCALE:	DATE: 2016.09.01

(C) Copyright reserved. No unauthorized use allowed.
 All intellect - ideas - concepts remain the property of Highfield Boats