

LONGITUDINAL PROFILE

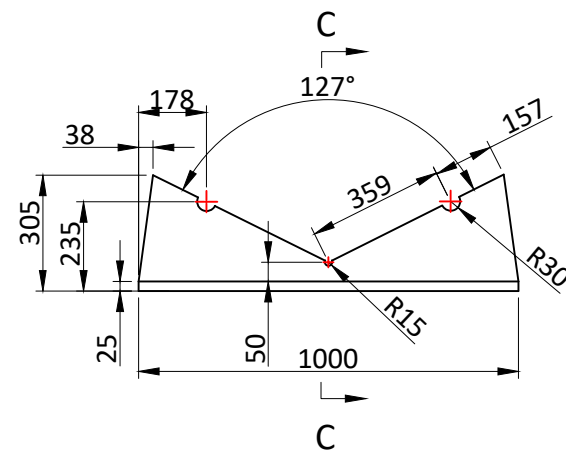

TRANSVERSAL SECTION "A"

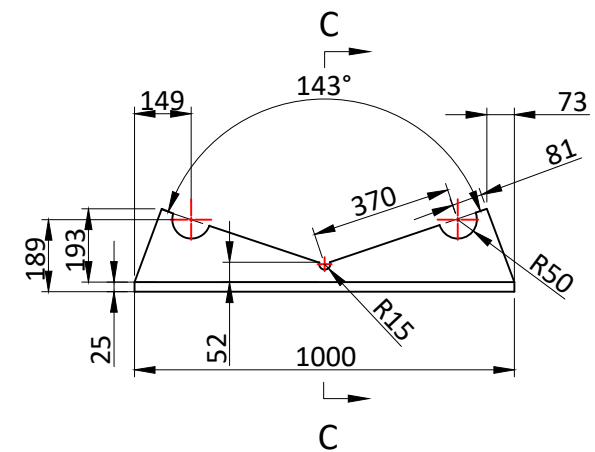

TRANSVERSAL SECTION "B"

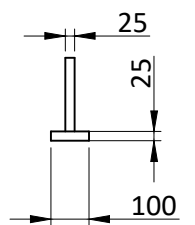

TRANSVERSAL SECTION "C"



SP390 CHOCK

DWN: JMM

APPROVED: LXL

info@highfieldboats.com

DWG:

SCALE:

DATE: 2024.12.9

(C) Copyright reserved. No unauthorized use allowed.
All intellect - ideas - concepts remain the property of Highfield Boats