

LONGITUDINAL PROFILE

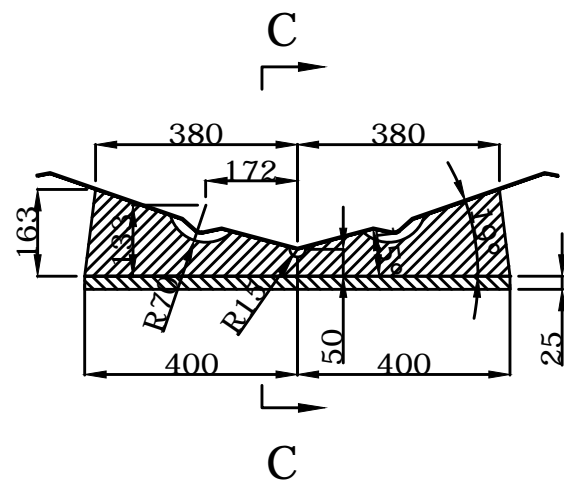

TRANSVERSAL SECTION "A"

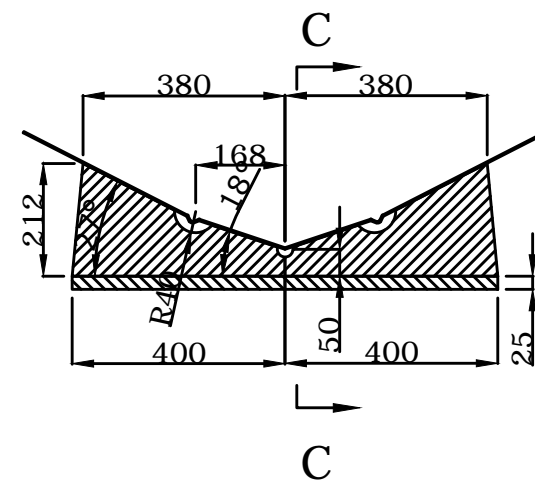

TRANSVERSAL SECTION "B"

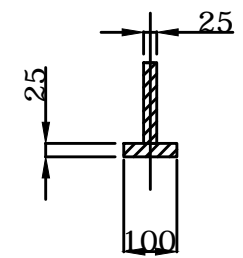

TRANSVERSAL SECTION "C"

	CL340DL		DWN: SYJ
	CHOCK ARRANGEMENT		APPROVED: LXJ
info@highfieldboats.com	DWG:	SCALE:	DATE: 2018.09.15

(C) Copyright reserved. No unauthorized use allowed.
All intellect - ideas - concepts remain the property of Highfield Boats