

LONGITUDINAL PROFILE

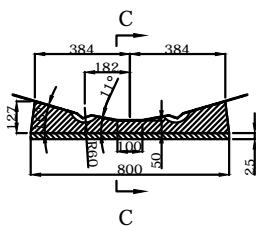

TRANSVERSAL SECTION "A"

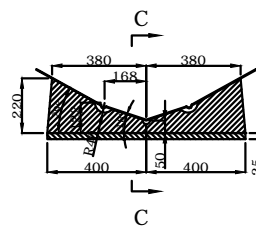

TRANSVERSAL SECTION "B"

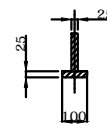

TRANSVERSAL SECTION "C"

| | | |
|---|-------------------|------------------|
|  HIGHFIELD aluminium RIBs | UL260 | DWN: HCY |
| | CHOCK ARRANGEMENT | APPROVED: LXL |
| info@highfieldboats.com | DWG: | SCALE: |
| | | DATE: 2016.09.01 |

(C) Copyright reserved. No unauthorized use allowed.
 All intellect - ideas - concepts remain the property of Highfield Boats

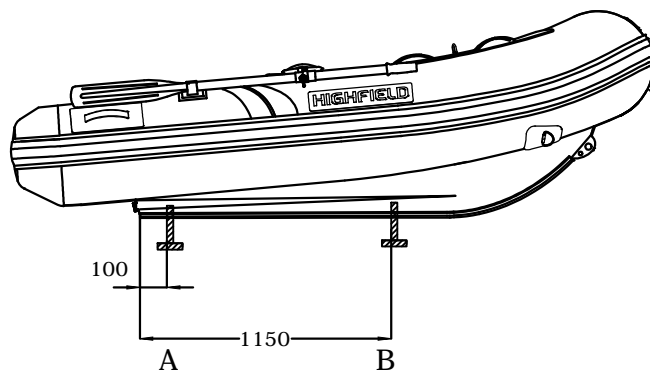
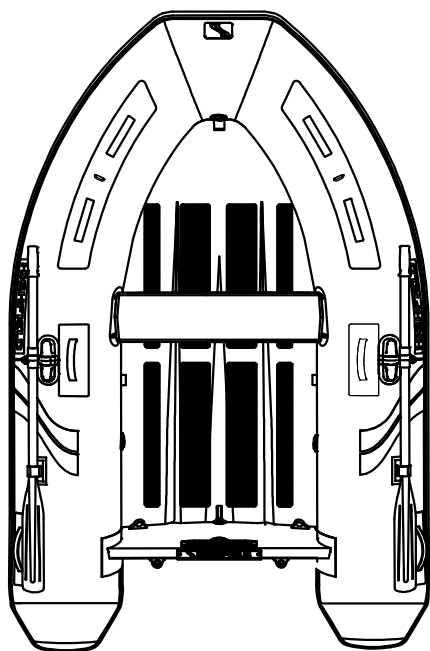

LONGITUDINAL PROFILE

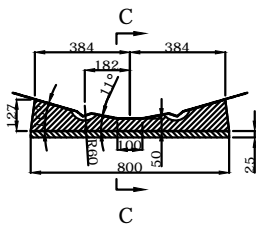

TRANSVERSAL SECTION "A"

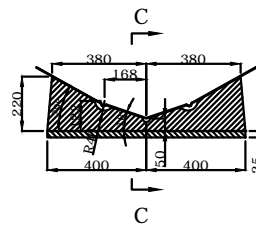

TRANSVERSAL SECTION "B"

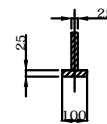

TRANSVERSAL SECTION "C"

| | | |
|--|-------------------|------------------|
|  HIGHFIELD aluminium RIBs | UL260LT | DWN: HCY |
| | CHOCK ARRANGEMENT | APPROVED: LXL |
| info@highfieldboats.com | DWG: | SCALE: |
| | | DATE: 2016.09.01 |

(C) Copyright reserved. No unauthorized use allowed.
 All intellect - ideas - concepts remain the property of Highfield Boats